

ベースプレート工法【BP型】

■KR2【柱幅50×50】 300型

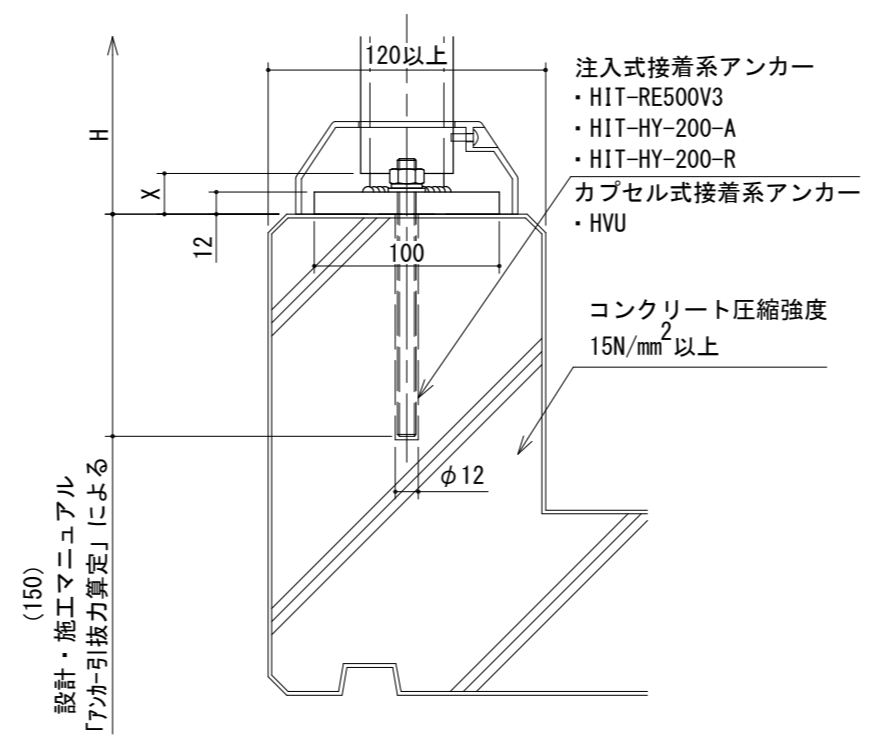

【支柱ベース】

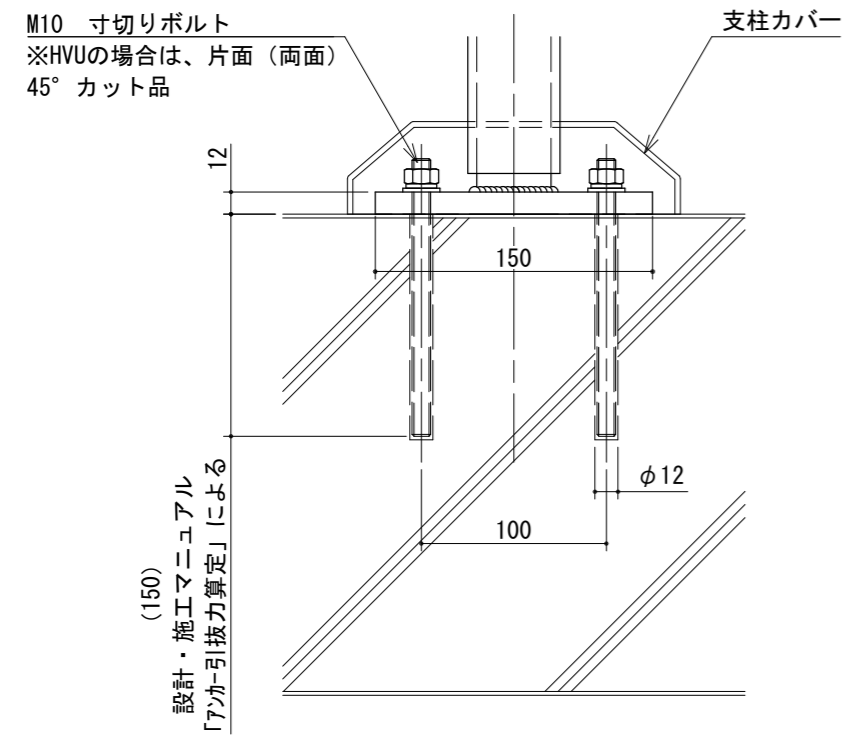
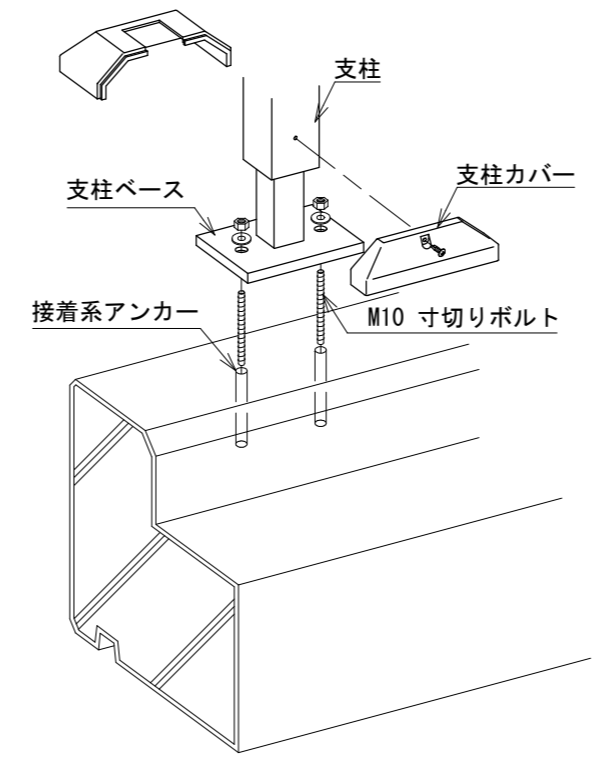
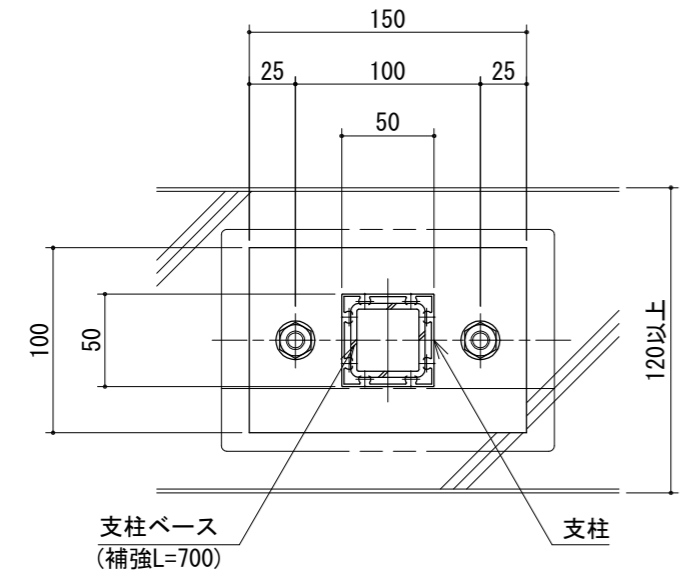